

Characteristics:

General Description: The Power Supply System type PSS1250 is an anodized aluminum 19" Rack unit (4U high) suitable to accept up to 6 plug-in Power Supply Modules type PSM1250 and 1 Overview module for diagnostic functions. Each module provides 24Vdc, 50 A output. Modules can be paralleled with load sharing circuits which distribute current load equally to each power supply module to increase reliability and reduce internal power dissipation. The system accepts up to two independent AC power sources with nominal voltage range 110 to 240 Vac ($\pm 10\%$). Twenty configurations of 19" Rack Units are available with or without Hot Swapping: ten for wall mounting and ten for frontal rack mounting, always into a cabinet. Two configurations of 9" Rack Units are available with or without Hot Swapping, only for wall mounting into a cabinet. For more information about different configurations see page 2.

Hot Swap Plug-ins: When using rack PSS1250-HS-7 (except for -HS-7-0 and -HS-7-5) or PSS1250-HS-3 or PSS1250-HS-2, each PSM1250 power supply module can be placed in Zone 2 / Div. 2 Hazardous Locations without having to monitor the hazardous gas presence and without disturbing Power Supply operations.

Diagnostic: Racks PSS1250-HS-7 or PSS1250-7 and PSS1250-HS-3 or PSS1250-3, accept a plugin module (PSO1250) dedicated to monitoring all diagnostic functions of each power supply, via a front panel touch screen LCD color display which indicates Input/Output Voltage, Current and Power, Input Line Frequency; Output current sharing percentage; Internal Temperature; alarm status. RS485 Modbus output provides full diagnostic and status conditions. PSO1250 presence or fault does not affect PSS1250 operation and functional safety application.

Overvoltage protection: 3 independent overvoltage protections:
1 voltage limiting loop at 30 Vdc and 1+1 crowbars at 30 Vdc.

EMC: Fully compliant with CE marking applicable requirements.

High load fuses breaking capability: In case of short circuit on the load, the Power supply system delivers a very high peak current (about 800 Amp) for a duration of 0.5 ms. This characteristic ensures the instant breakage of the protective fuse or circuit breaker. Because of the very short peak current duration, other equipment connected to the load are not affected by the failure event and continue to operate without interruption.

Functional Safety Management Certification:

G.M. International is certified by TUV to conform to IEC61508:2010 part 1 clauses 5-6 for safety related systems up to and included SIL3.

Features:

- SIL 3 for NE Load according IEC 61508:2010, with single PSM1250 module or more PSM1250 modules in redundant configuration (see ISM0219 for more information).
- SIL 1 for ND Load according to IEC 61508:2010, with single PSM1250 module (see ISM0219 for more information).
- SIL 2 for ND Load according IEC 61508:2010, with more PSM1250 modules in redundant configuration (see ISM0219 for more information).
- Systematic capability SIL 3.
- 2 universal AC Input Lines, nominal 110 to 240 Vac ($\pm 10\%$) (48 to 62 Hz).
- Power factor correction.
- Installation in Zone 2 / Div. 2 hazardous locations with hot swappable modules (except for PSS1250-HS-7-0 and PSS1250-HS-7-5).
- EMC Compatibility to EN61000-6-2, EN61000-6-4.
- ATEX, IECEx, UL & C-UL Certifications (except for PSS1250(-HS)-7-0 and -7-5).
- TÜV Certification for Functional Safety of Product & Management of Functional Safety.
- Tested for maritime applications.
- Highly regulated output of 24 Vdc, 50 A, for PSM1250 module.
- Under and over voltage alarm monitoring.
- 3 over voltage redundant protections.
- Redundant parallel connections with load sharing (except for PSS1250(-HS)-7-0 & -7-5)
- Reduces Power dissipation (in parallel/redundant configuration) by replacing a Schottky diode with Mosfet Active Ideal Diode.
- 89% efficiency @230 Vac input and 24 Vdc output with full load.
- Fan speed control depending on ambient temperature and output power.
- High load fuse breaking capability without interrupting operations.
- 19" or 9" or 7" Rack unit, 4 U high, anodized aluminium, durable metal enclosure.
- Tropicalization for electronic components.
- Modbus RTU RS-485 diagnostic output (only for 19" or 9" rack units).

Single module PSM1250 Technical Data:
Supply:

AC Input voltage: nominal 110 to 240 Vac ($\pm 10\%$), with frequency range 48 to 62 Hz.
Power Factor Correction (AC input): 0.98 typ. @230Vac, 0.995 typ. @115Vac (50A out)
Efficiency @24Vdc out (50 A out): better than 89 % @ 230 Vac and 86% @ 115 Vac.
Max. internal power dissipation @24Vdc out (50 A out): 150 W @ 230 Vac;
195 W @ 115 Vac.

AC input current (sinusoidal at 50A out) @24Vdc out: 14.2A @100Vac input voltage, 12.2 A @115 Vac input voltage, 6.1 A @230 Vac input voltage.

Inrush current: 37 A peak @264 Vac; 32 A peak @ 230 Vac; 16 A peak @ 115 Vac.

AC input connection: screw terminal blocks suitable for 4mm² wires on back panel pcb.

Isolation (Test Voltage):

Input to Output isolation: 2500 Vrms (routine test).

Input to Earth-Ground isolation: 1500 Vrms (routine test).

Earth-Ground to Output isolation: 500 Vrms (routine test).

Output or Earth-Ground to Fault contact isolation: 500 Vrms (routine test)

Output:

Output voltage: 24 Vdc (adjustable from 21 to 28 Vdc).

Regulation: 0.4 % for a 100 % load change.

Stability: 0.01 % for a 20 % line voltage change.

Ripple: ≤ 250 mVpp.

Output current: 50 A nominal (@24Vdc out). Parallel connection for redundancy with load sharing capability within $\pm 5\%$ of output voltage setting.

Only for PSS1250(-HS)-7-0 & -7-5, max 33 A out without redundant parallel connections.

Output power: @28Vdc out, up to 1300 W (except 900 W for PSS1250(-HS)-7-0 & -7-5).

Output Rise Time: 2.5 s.

Dynamic Response: 2 ms for 0-100% load change (overshoot $\pm 1.5\%$ of Vout setting).

Connection: M6 screw terminals on copper bars suitable for lug (at least 6.5 mm hole diameter) with 16mm² wire on back panel pcb.

Hold-up time (AC input): 20 ms (50A out); 30 ms (33A out).

Over voltage protection: output limited to 30 Vdc plus two redundant crowbars for over voltage protection at 30 Vdc.

Power good signaling: Output good: 19.5 V \leq Vout \leq 29.5 V.

Indication: via LCD screen on PSO1250 and Modbus RTU RS-485 protocol.

Signaling: voltage free SPST normally energized relay (contact closed), de-energize in over/under voltage conditions (contact open).

Contact Rating: 2 A 50 Vac 100 VA, 2 A 24 Vdc 48 W (resistive load).

Connection, on back panel pcb:

- for all configurations except for PSS1250(-HS)-7-0 & -7-5: Fault & Comm. Fault & Modbus with screw terminal blocks suitable for 1.5 mm² wires;

- only for PSS1250(-HS)-7-0 & -7-5: Fault & Comm. Fault with push-in spring connection terminal blocks suitable for 1.3 mm² wires; Modbus with screw terminal blocks suitable for 1.5 mm² wires.

Compatibility:

CE mark compliant, conforms to Directive:

2014/34/EU ATEX, 2014/30/EU EMC, 2014/35/EU LVD, 2011/65/EU RoHS.

Environmental conditions:

Operating temperature limits: -40 to +70°C de-rated linearly 65-70% load above 50°C (see Power Output vs. Ambient Operating Temperature diagram at page 10).

Relative humidity limits: 95 %, up to 55 °C.

Transport, storage temperature limits: - 45 to + 85 °C. **Max altitude:** 2000 m a.s.l.

Safety Description: For all configurations (except for PSS1250(-HS)-7-0 & -7-5)

ATEX: II 3G Ex ec nC IIC T4 Gc. **IECEx:** Ex ec nC IIC T4 Gc.

UL: NI // I / 2 / ABCD / T4; **C-UL:** NI // I / 2 / ABCD / T4.

CCC: Ex ec nC IIC T4 Gc

Approvals: For all configurations (except for PSS1250(-HS)-7-0 & -7-5):

BVS 15 ATEX E 006 X conforms to EN60079-0, EN60079-7, EN60079-11, EN60079-15

IECEx BVS 15, 0006X conforms to IEC60079-0, IEC60079-7, IEC60079-11, IEC60079-15

UL & C-UL E498342 conforms to UL 61010-1, UL 121201 for UL and

CAN/CSA C22.2 No.61010-1-12, CSA C22.2 No. 213 for C-UL.

CCC n. 2020322303000822 conforms to GB/T 3836.1, GB/T 3836.3, GB/T 3834.8

For all configurations: TÜV Certificate No. C-IS-236198-04 SIL 2 / SIL 3 conform to

IEC 61508:2010 Ed. 2. SIL 3 Functional Safety TÜV Certificate conforms to

IEC61508:2010 Ed. 2, for Management of Functional Safety.

Mechanical: Mounting: 7" or 9" or 19" Rack unit, 4 units high.

7" or 9" Rack unit for wall mounting, into a cabinet.

19" Rack unit for wall mounting or for frontal rack mounting, into a cabinet.

Weight: 7" fully equipped about 7 Kg, fully equipped with 2 PSM1250.

9" fully equipped about 10 Kg, fully equipped with 2 PSM1250 and 1 PSO1250 module.

19" fully equipped about 24 Kg, fully equipped with 6 PSM1250 and 1 PSO1250 module.

Location: installation in Safe Area/Non Hazardous Locations or Zone 2, Group IIC T4 or

Class I, Division 2, Group A,B,C,D, T4 (except for PSS1250(-HS)-7-0 and -7-5).

Protection class: IP 20, Open Type. **Dimensions:** see drawings pages 4 to 9.

Images:
Example configurations:

PSS1250-HS-2 +
2 x PSM1250









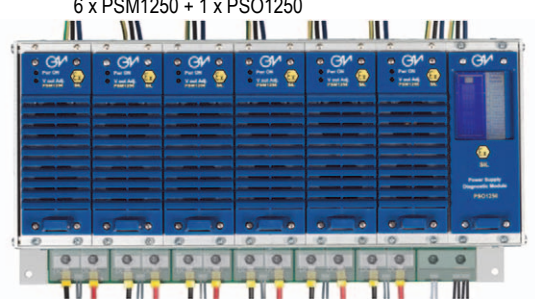

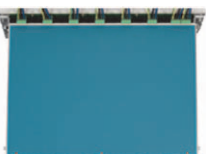

PSS1250-HS-3 +
2 x PSM1250 + 1 x PSO1250

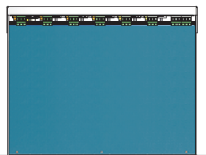

PSS1250-HS-7 (wall mounting version shown) +
6 x PSM1250 + 1 x PSO1250



Ordering Information:

Description	Hot Swapping	Rack Dimension (inches) and Configuration	Ordering Code
 <p>Rack unit and back panel for wall mounting into a cabinet</p>	YES	19" wide 6 outs 24Vdc..each up to 33A without redundancy→ 1 out 24Vdc.....up to 150A with redundancy→ 2 outs 24Vdc...up to 100A & 50A with redundancy→ 3 outs 24Vdc.....each up to 50A with redundancy→ 2 outs 24Vdc.....each up to 100A with redundancy→ 1 diagnostic module (optional)	PSS1250-HS-7-0-D PSS1250-HS-7-1-D PSS1250-HS-7-2-D PSS1250-HS-7-3-D PSS1250-HS-7-4-D
 <p>Rack unit and back panel for wall mounting into a cabinet</p>	NO	19" wide 6 outs 24Vdc..each up to 33A without redundancy→ 1 out 24Vdc.....up to 150A with redundancy→ 2 outs 24Vdc...up to 100A & 50A with redundancy→ 3 outs 24Vdc.....each up to 50A with redundancy→ 2 outs 24Vdc.....each up to 100A with redundancy→ 1 diagnostic module (optional)	PSS1250-7-0-D PSS1250-7-1-D PSS1250-7-2-D PSS1250-7-3-D PSS1250-7-4-D
 <p>Rack unit and back panel for frontal rack mounting into a cabinet</p>	YES	19" wide 6 outs 24Vdc..each up to 33A without redundancy→ 1 out 24Vdc.....up to 150A with redundancy→ 2 outs 24Vdc...up to 100A & 50A with redundancy→ 3 outs 24Vdc.....each up to 50A with redundancy→ 2 outs 24Vdc.....each up to 100A with redundancy→ 1 diagnostic module (optional)	PSS1250-HS-7-5-D PSS1250-HS-7-6-D PSS1250-HS-7-7-D PSS1250-HS-7-8-D PSS1250-HS-7-9-D
 <p>Rack unit and back panel for frontal rack mounting into a cabinet</p>	NO	19" wide 6 outs 24Vdc..each up to 33A without redundancy→ 1 out 24Vdc.....up to 150A with redundancy→ 2 outs 24Vdc...up to 100A & 50A with redundancy→ 3 outs 24Vdc.....each up to 50A with redundancy→ 2 outs 24Vdc.....each up to 100A with redundancy→ 1 diagnostic module (optional)	PSS1250-7-5-D PSS1250-7-6-D PSS1250-7-7-D PSS1250-7-8-D PSS1250-7-9-D
 <p>Rack unit and back panel for wall mounting into a cabinet</p>	YES	9" wide 1 out 24Vdc.....up to 50A with redundancy→ 1 diagnostic module (optional)	PSS1250-HS-3-D
 <p>Rack unit and back panel for wall mounting into a cabinet</p>	NO	9" wide 1 out 24Vdc.....up to 50A with redundancy→ 1 diagnostic module (optional)	PSS1250-3-D
 <p>Rack unit and back panel for wall mounting into a cabinet</p>	YES	7" wide 1 out 24Vdc.....up to 50A with redundancy→	PSS1250-HS-2
 <p>Rack unit and back panel for wall mounting into a cabinet</p>	NO	7" wide 1 out 24Vdc.....up to 50A with redundancy→	PSS1250-2
 <p>Power supply module</p>	-	With 24 Vdc – 50 A output	PSM1250 : 2 pcs for 50 A out with n+1 or n+n redund. 3 or 4 pcs for 100 A out with n+1 or n+n redund. 4 or 5 or 6 pcs for 150 A out with n+1 or n+2 or n+n redundancy
 <p>Diagnostic module</p>	-	With touch screen LCD color display	PSO1250 : 1 piece (optional) plugged into 7th (19" rack) or 3rd (9" rack) slot if diagnostic is required
 <p>Blank panel</p>	-	To fill a not used rack slot, where a PSM1250 or PSO1250 is not installed	MCHP228

Hot swapping capability

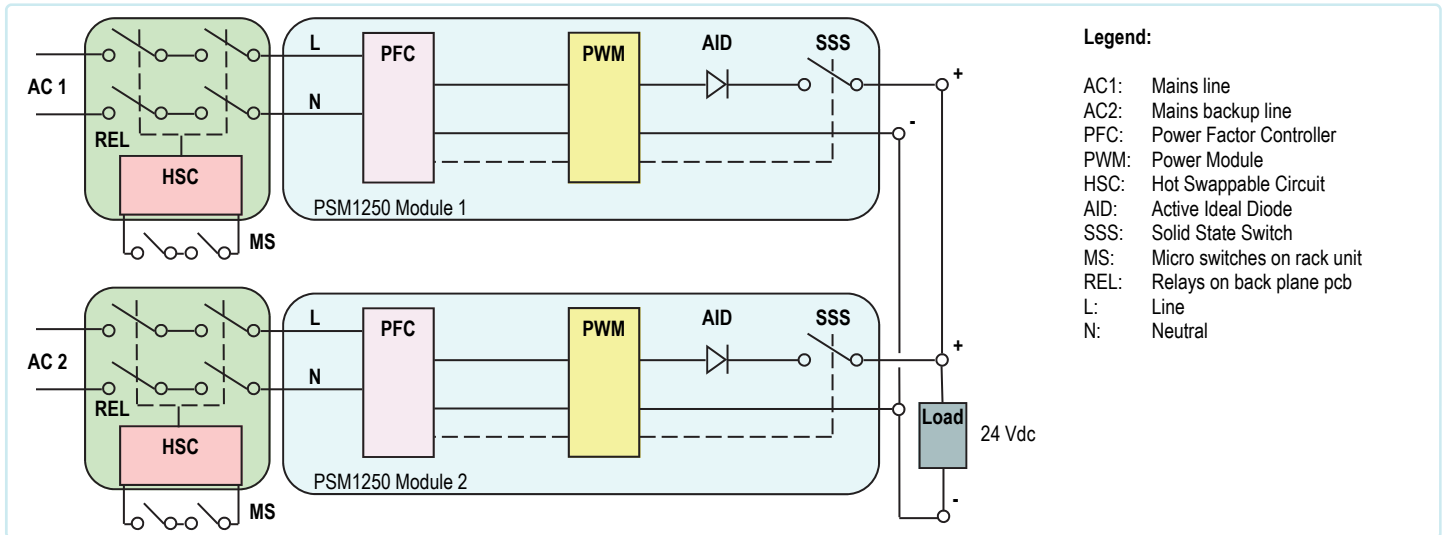

PSS1250 Power Supply System is able to provide power and installed in Zone 2 / Div. 2 (valid for all configurations except for PSS1250(-HS)-7-0 & -7-5), without the need to monitor hazardous gas presence and without disturbing power supply operations, because it is fully protected from the Hot Swapping of any power, or diagnostic, module. This protection system operates for both the insertion and disconnection of the modules.

When inserting the module, the mains voltage is only applied when mechanical and electrical module connections are completely and correctly positioned, while before disconnecting the module the external electrical connections have to be at zero voltage level.

To achieve this result, a sophisticated 1oo2 mechanical and electrical protection circuit, using micro switches (MS), relays (REL) and special hot swapping circuits (HSC), has been designed. All power modules have a mains terminal block for Line-Neutral-Earth/Ground, placed in the back panel pcb that can be used for two independent mains lines (AC1 & AC2). The Line and Neutral are connected to the power module via two couples of 1oo2 series contact relays, driven from hot swapping circuit according to closed or open state of 1oo2 series mechanical switches. Two micro switches for each power module are placed in the front part of the 7" or 9" or 19" Rack unit and are activated (closed) by front panel top screws used to fix the module at rack. 24 relays (4 for each power module) are installed on the back panel pcb, close to the mains terminal blocks, in 1oo2 architecture for safety purposes. For further safety, close to the relays, for each position, there is a red LED (total 6 LEDs). Before inserting a power module, the operator must verify that related red LED is OFF.

If the red LED is turned ON, a failure is present on a couple of series relays. Therefore no power module shall be inserted and fixed into that position of the rack unit in Zone 2/Div.2 (valid for all configurations except for PSS1250(-HS)-7-0 & -7-5), because it can be a danger.

The opening of the micro switches, operated by unscrewing at least one of two front panel top screws, initiates the following two actions:

1. Mains line is disconnected from the power module, because hot swapping circuit de-energizes relays, opening their contacts;
2. Voltage on the power module connectors is brought to 0 volts, to avoid any sparking possibility. This is done by a MOSFET solid state switch (SSS) connected in series with the *active ideal diodes (AID)*, which disconnects the output from the DC output bus. The internal voltage in the disconnected power module remains completely isolated from the output connections and therefore, even if an operator shorts the connections with a screw driver or any other tool, this will not generate a spark.

When a power module is inserted and fixed to rack unit by its screws, the MOSFET solid state switch remains open until the power supply starts to operate correctly, then it closes itself applying voltage to the load.

Reasons for using an Ideal Diode-OR Controller circuit, in N+1 redundant power supply applications with high availability systems

High availability systems often employ power supply modules connected in parallel to achieve redundancy and enhance system reliability.

ORing diodes have been a popular means of connecting these supplies at a point of load. The disadvantage of this approach is the forward voltage drop and resulting efficiency loss. This drop reduces the available supply voltage and dissipates significant power.

Replacing Schottky diodes with N-channel MOSFETs reduces power dissipation and eliminates the need for expensive heat sinks or large thermal layouts in high power applications. In the Ideal Diode-OR Controller circuit (*active ideal diode*), the voltage across source and drain is monitored by IN and OUT pins, and GATE pin drives the MOSFETs to control their operation. In effect the MOSFET source and drain serve as the anode and cathode of an ideal diode.

In the event of a power supply failure, for example if the output of a fully loaded supply is suddenly shorted to ground, reverse current temporarily flows through the MOSFETs that are ON. This current is sourced from any load capacitance and from the other supplies. The active ideal diode quickly responds to this condition turning off the MOSFETs in about 0.5µs, thus minimizing disturbance and oscillations to the output bus.

Using Oring diodes to parallel two, or more, 24 VDC power supply modules for redundancy, one Schottky diode is used for each module. The voltage drop across the diode can reach about 0.8 V at 50 A, this means about 40 W dissipation for each module. Then, if six 50 A paralleled modules are used for full 150 + 150 A redundancy, a total power of about **240 W** is dissipated for this purpose. This reduces efficiency, reliability and increases space for heat sinks. Moreover, in case of module failure, diodes take time to recover and consequently they do not preserve the load from transients during the backup operation.

To avoid all these problems G.M. International has introduced, in the new PSS1250 Power Supply System, the use of *active ideal diodes*.

The MOSFETs resistance for *active ideal diodes* is about 1.2 mΩ resulting in 3.6 W dissipation for each power module. Then, if six 50 A paralleled modules are used for full 150 + 150 A redundancy, a total power of about **22 W** is dissipated for the purpose resulting in about **ten times less** dissipation compared to Schottky diodes solution. This increases efficiency, reliability, availability and reduces space for heat sinks.

This circuit provides also very smooth voltage switchovers without oscillations with fast turnoff, minimizing reverse current transients.

Output voltage setting - Fault indications - Diagnostic information

For each PSM1250 power module, the output voltage can be set to 24 Vdc + 18%; -14% via a front panel trimmer.

Under voltage threshold is set to 19.5 V, while Over voltage threshold is set to 29.5 V.

A front panel power ON LED signals mains voltage is applied to the power module and normal DC output voltage is present on DC output bus.

Power module Fault conditions are signaled by opening contact of NE relay (contact closed in normal condition), positioned on back panel pcb "Fault" terminal block.

Faults can be:

- Under voltage Vout < 19.5 V.
- Over voltage Vout > 29.5 V.

In absence of under / over voltage fault, the green Power ON LED is ON if output voltage is within 19.5 V - 29.5 V range.

If output voltage goes below 19.5 V, the green Power ON LED blinks and holds this condition as long as output voltage goes over 20 V.

If output voltage goes over 29.5 V, the green Power ON LED is OFF and holds this condition as long as output voltage goes below 29 V.

After under / over voltage fault, coming back to normal condition, the green Power ON LED is ON if output voltage is within 20 V - 29 V range.

Communication with six (for PSS1250-7) or two (for PSS1250-3) power modules is achieved via PSO1250 diagnostic module (only for PSS1250 with -D suffix), which incorporates a front panel color touch screen. The diagnostic module is able to query each power modules (using an internal proprietary bus) and read data such as, Input/Output Voltage, Current and Power; Input Line Frequency; Output current sharing percentage; Internal Temperature; alarm status (under/over out voltage, AC line absence, internal PFC or PWM stage in OFF state, internal high temperature, fans malfunctioning). This information is available via front panel LCD and externally via Modbus RTU on related wall mounting terminal block.

Alarm status of one or more power modules is signalled by opening contact of NE relay (contact closed in normal condition), positioned on back panel pcb "Comm. Fault" terminal block. The diagnostic module **does not interfere** with the Power system functional safety. The power system can perfectly work without the diagnostic module and any failure of the diagnostic module does not affect system performance, reliability and SIL level of Functional Safety applications.

Back Panel of PSS1250-xx-7-0/1/2/3/4-D (for wall mounting into a cabinet) overall dimensions:

The following drawing with overall dimensions (mm) is only applicable to types: PSS1250-HS-7-0/1/2/3/4-D and PSS1250-7-0/1/2/3/4-D.

The back panel is fixed to a vertical wall into a cabinet by means of four screws through four 7.00 mm diameter holes shown in the drawing.

The back panel must only be installed as oriented in the following drawing. On the back panel is fixed the back panel PCB by means of six screws.

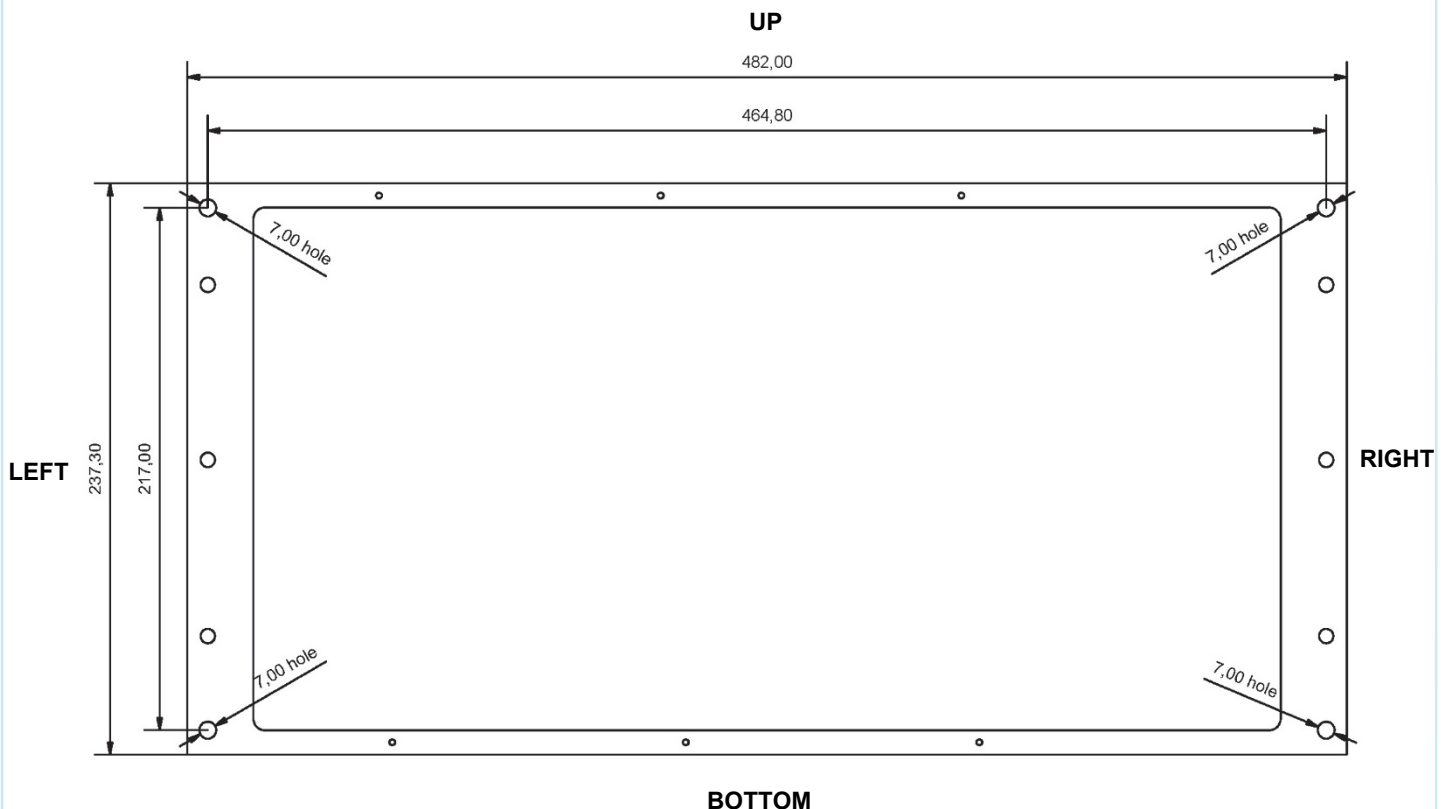

Back Panel of PSS1250-xx-3-D and PSS1250-xx-2 (for wall mounting into a cabinet) overall dimensions:

The following drawing with overall dimensions (mm) is only applicable to types: PSS1250-HS-3-D and PSS1250-3-D.

The back panel is fixed to a vertical wall into a cabinet by means of four screws through four 7.00 mm diameter holes shown in the drawing.

The back panel must only be installed as oriented in the following drawing. On the back panel is fixed the back panel PCB by means of six screws.

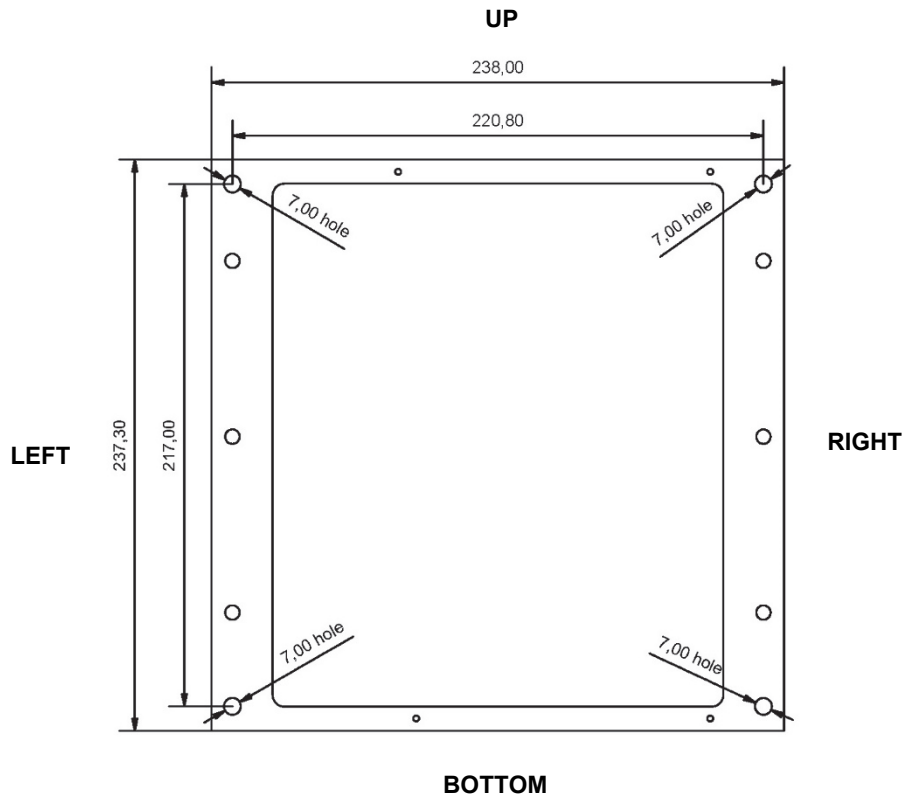

The following drawing with overall dimensions (mm) is only applicable to types: PSS1250-HS-2 and PSS1250-2.

The back panel is fixed to a vertical wall into a cabinet by means of four screws through four 7.00 mm diameter holes shown in the drawing.

The back panel must only be installed as oriented in the following drawing. On the back panel is fixed the back panel PCB by means of six screws.

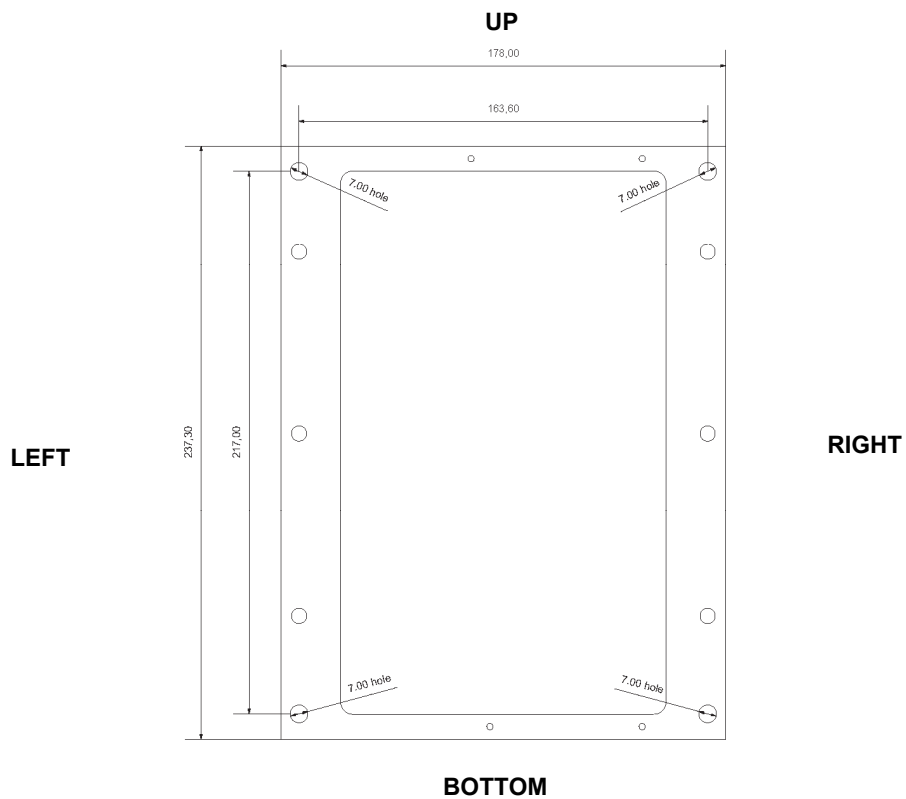

PSS1250-HS-7-0/1/2/3/4-D & PSS1250-7-0/1/2/3/4-D (for wall mounting into a cabinet) overall dimensions:

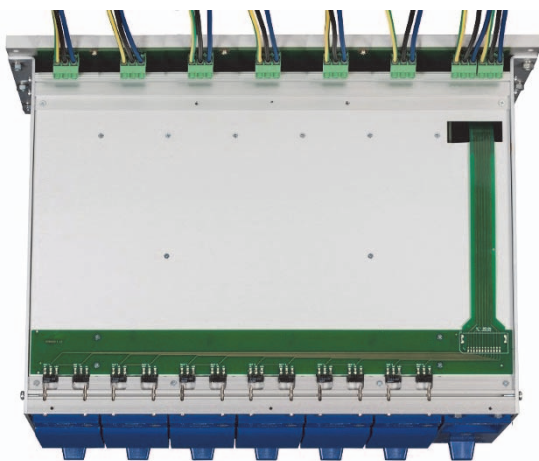
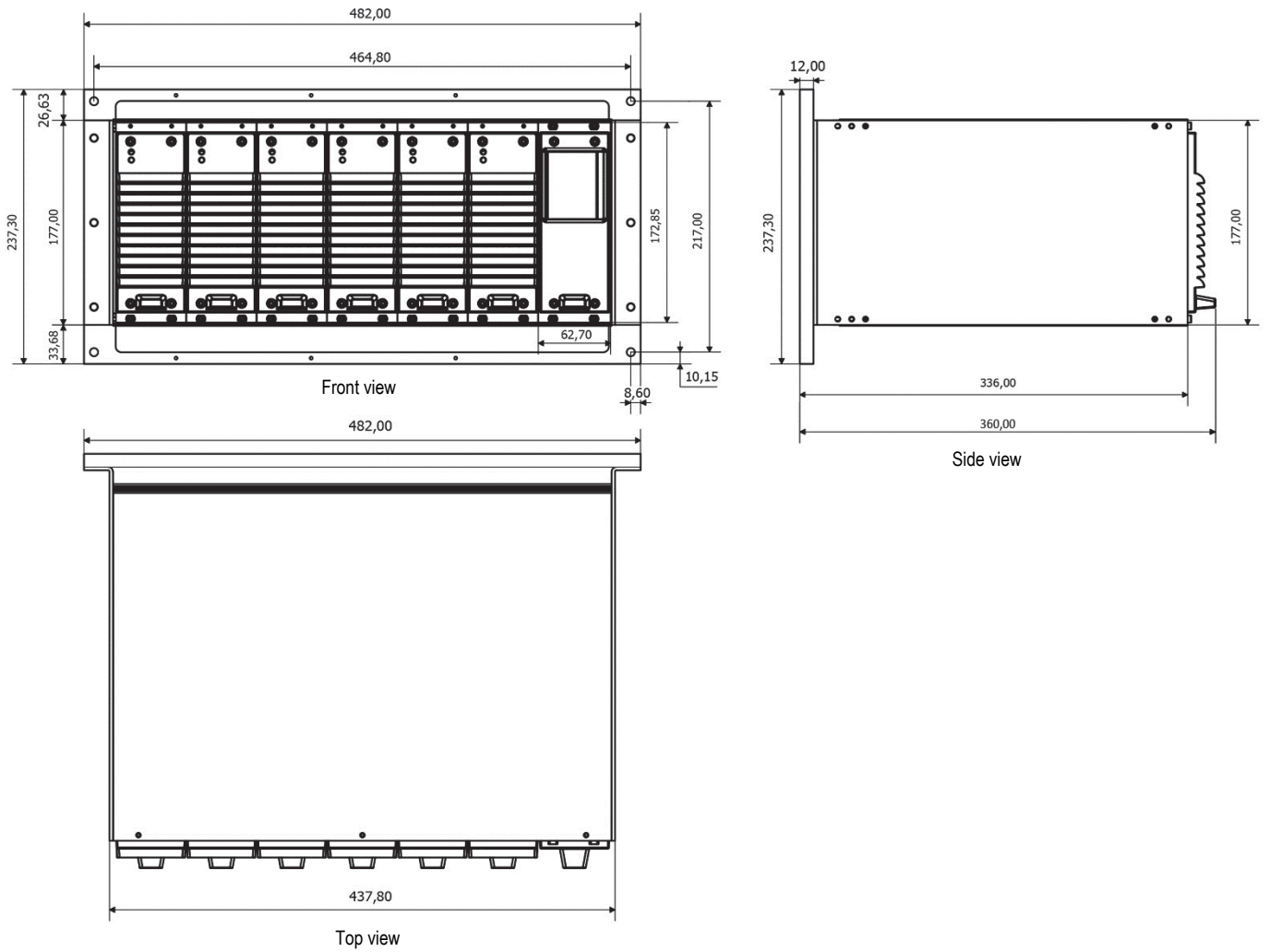

19" Rack Unit type PSS1250-HS-7-0/1/2/3/4-D
Top view without cover

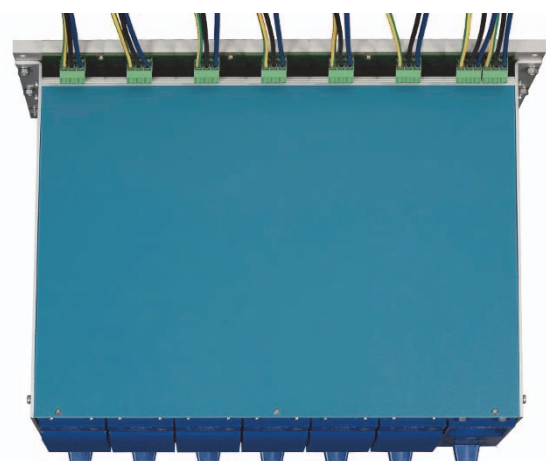

19" Rack Unit type PSS1250-HS-7-0/1/2/3/4-D
Top view with cover

PSS1250-HS-7-5/6/7/8/9-D & PSS1250-7-5/6/7/8/9-D (for frontal rack mounting into a cabinet) overall dimensions:

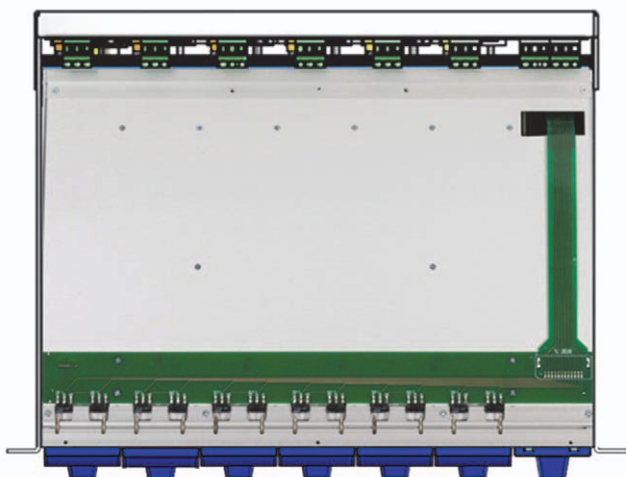
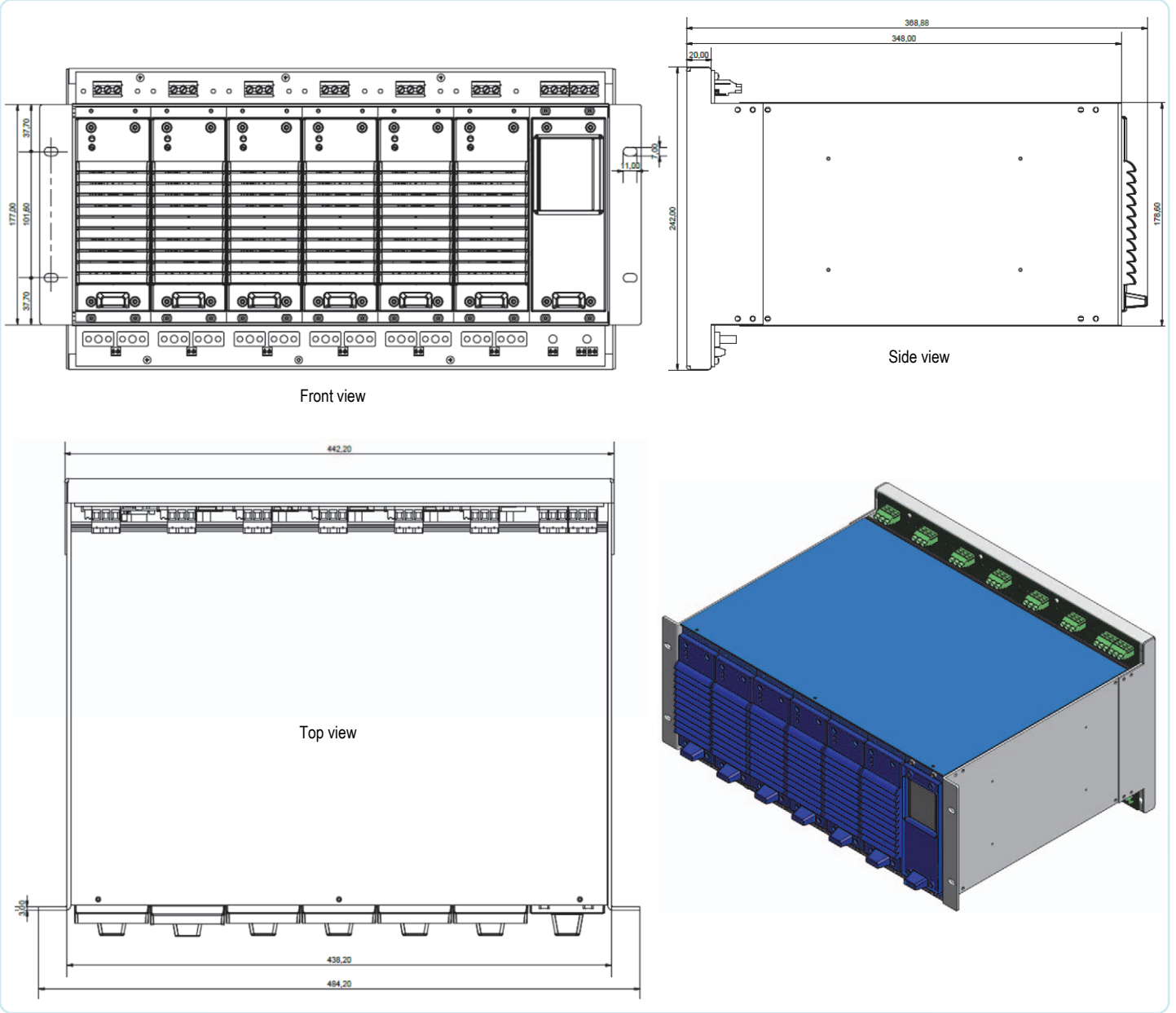

19" Rack Unit type PSS1250-HS-7-5/6/7/8/9-D
Top view without cover



19" Rack Unit type PSS1250-HS-7-5/6/7/8/9-D
Top view with cover

PSS1250-HS-3-D & PSS1250-3-D (for wall mounting into a cabinet) overall dimensions:

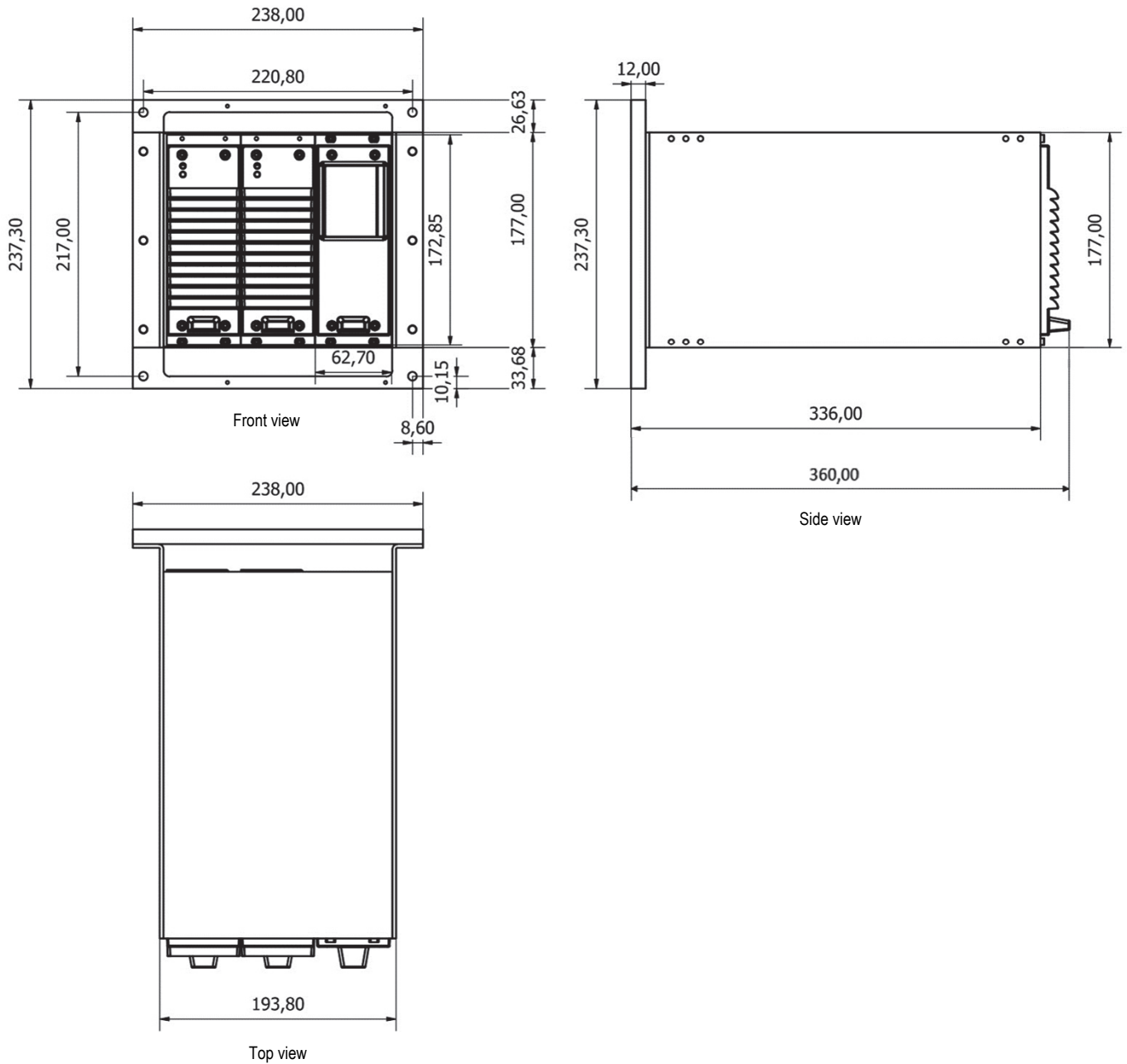

9° Rack Unit type PSS1250-HS-3
Top view without cover



9° Rack Unit type PSS1250-HS-3
Top view with cover

PSS1250-HS-2 & PSS1250-2 (for wall mounting into a cabinet) overall dimensions:

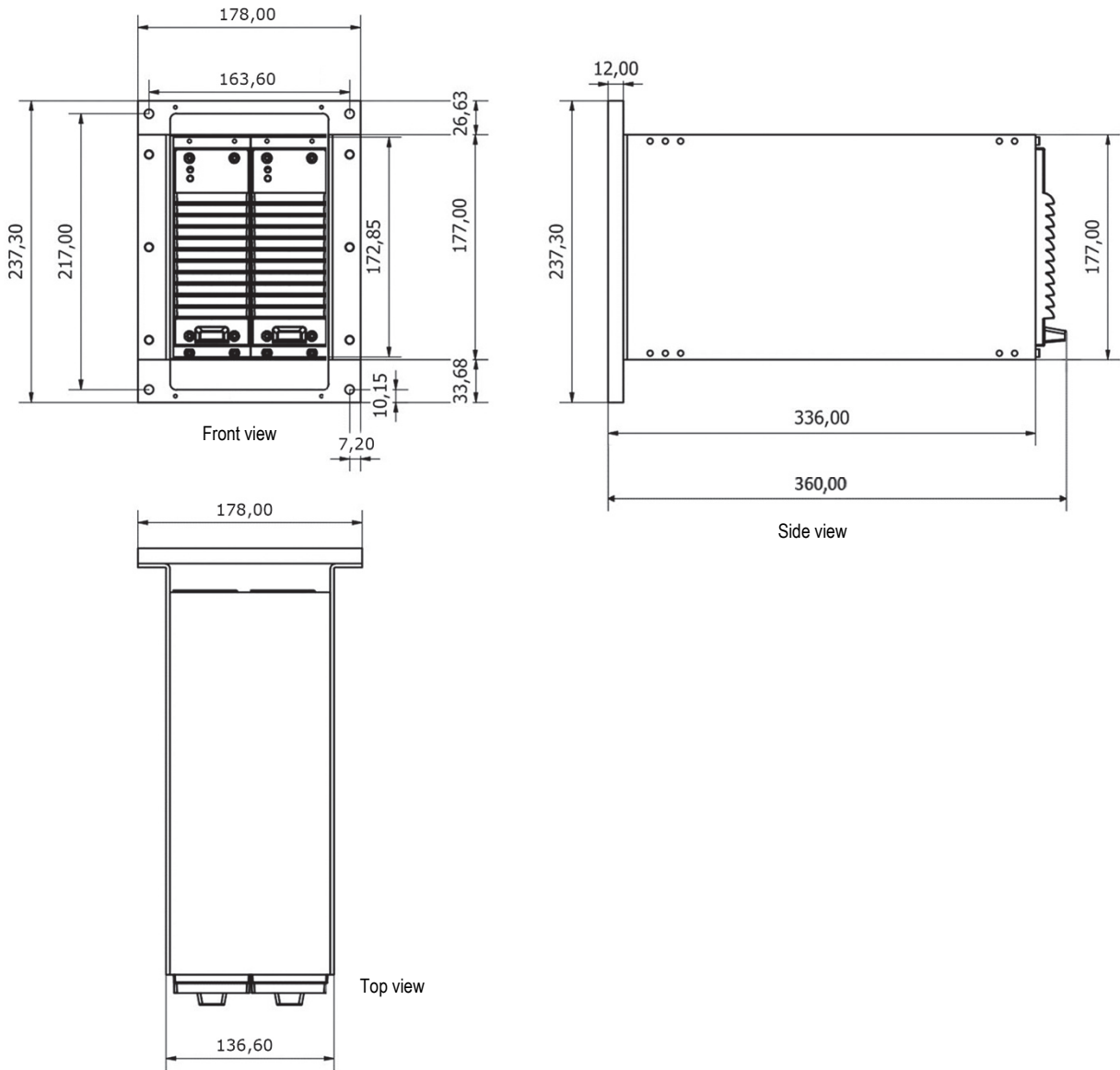

7" Rack Unit type PSS1250-HS-2
Top view without cover



7" Rack Unit type PSS1250-HS-2
Top view with cover



PSM1250
Side view

PSM1250
Maximum Output Power vs. Ambient Operating Temperature

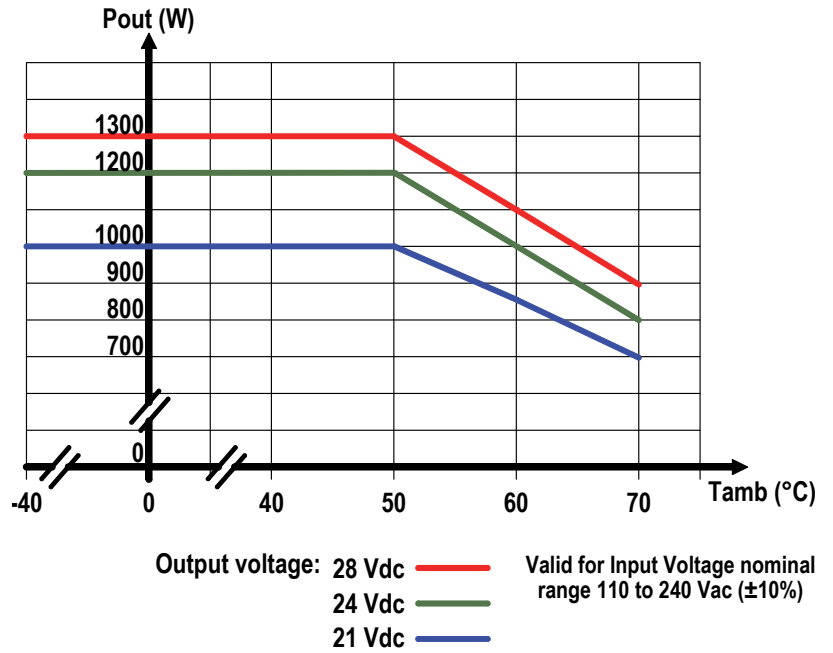

With 50% redundant configuration (two PSM1250 with paralleled outputs), each module can give 600 W power output up to 70°C operating ambient temperature, with output voltage range 21÷28 Vdc and input voltage nominal range 110÷240 Vac (±10%).

Only for PSS1250(-HS)-7-0 & -7-5, a single PSM1250 can give 900 W (@ 28 Vdc) or 800 W (@ 24 Vdc) or 700 W (@ 21 Vdc) power output and 33 A output up to 70°C operating ambient temperature, with input voltage nominal range 110÷240 Vac (±10%).



PSM1250
Top view



PSM1250
Front view



PSM1250
Side view without cover



PSO1250
Side view



PSO1250
Side view



PSO1250
Top view



PSO1250
Front view

PSO1250 supply information:

AC Input voltage (each AC terminal block): nominal 110 to 240 Vac ($\pm 10\%$), with frequency range 48 to 62 Hz.
AC input current (sinusoidal): 45 mA @ 100 Vac input voltage, 40 mA @ 115 Vac input voltage, 15 mA @ 230 Vac input voltage.
Inrush current: 1.6 A peak @ 264 Vac; 1.4 A peak @ 230 Vac; 0.7 A peak @ 115 Vac.

Function Diagram Dual AC Supply wiring architecture for PSS1250-HS-7-0/5-D or PSS1250-7-0/5-D fully equipped:

SAFE AREA,
NON HAZARDOUS LOCATIONS

PSS1250-HS-7-0-D or PSS1250-HS-7-5-D or PSS1250-7-0-D or PSS1250-7-5-D, dual AC supply, 6 x 33 A Outputs, PSO1250 overview module
six independent power modules to provide six independent 33 A outputs.

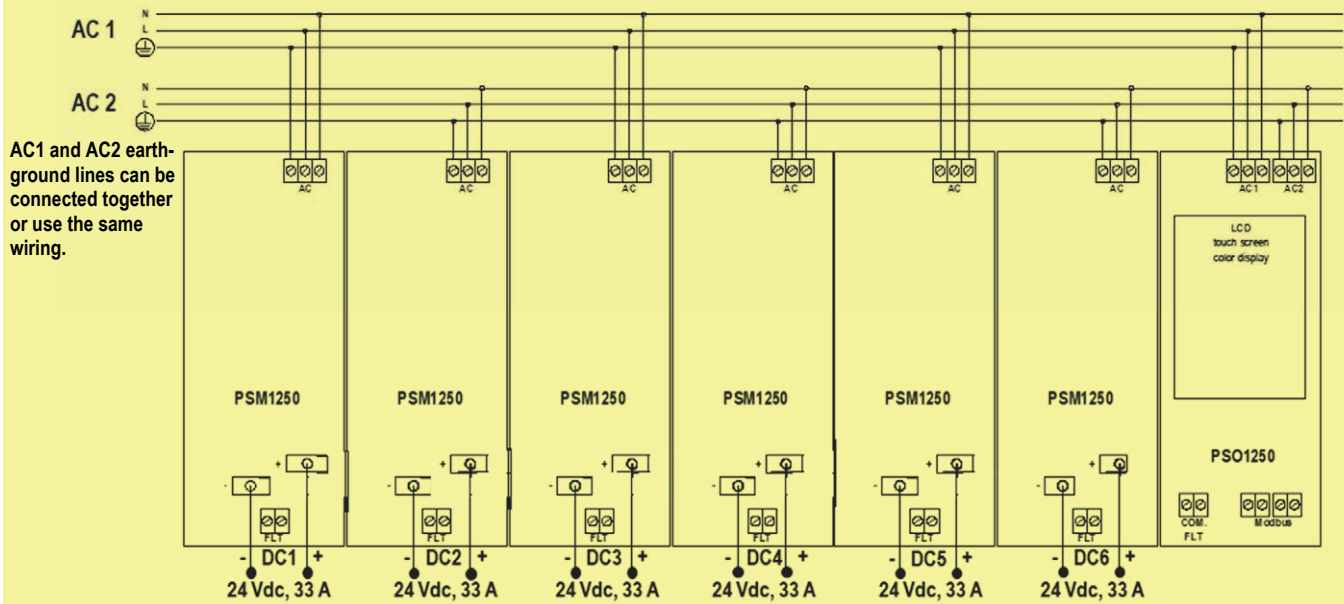

Back Panel PCB of PSS1250-HS-7-0-D or PSS1250-HS-7-5-D with Hot Swapping circuits:

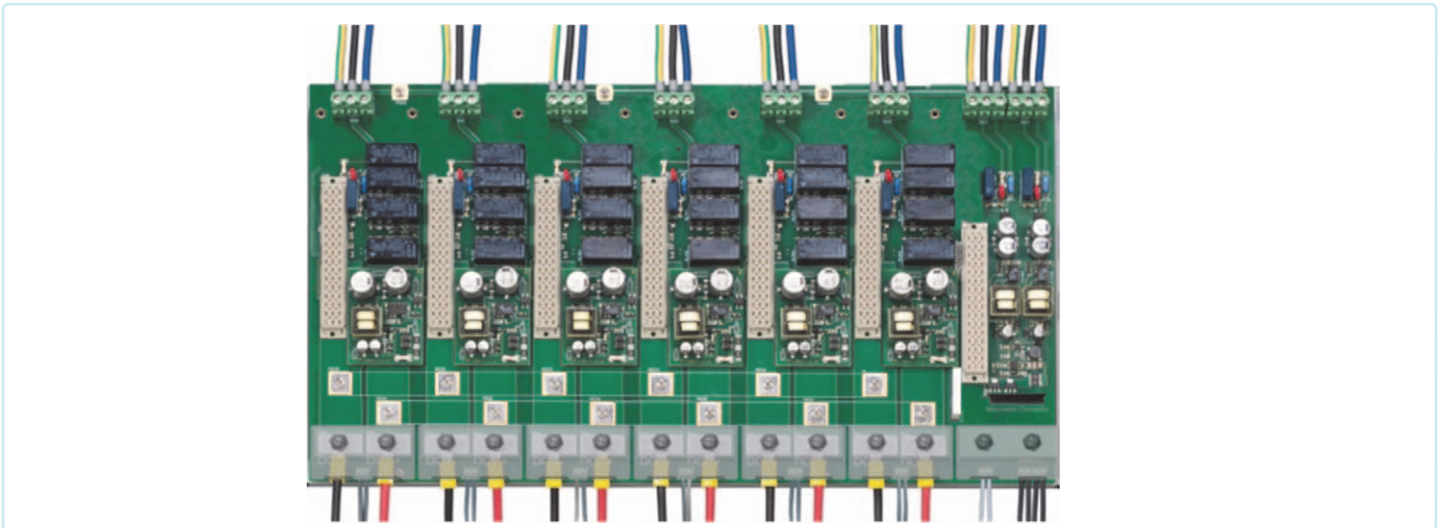

Back Panel PCB of PSS1250-7-0-D or PSS1250-7-5-D without Hot Swapping circuits:

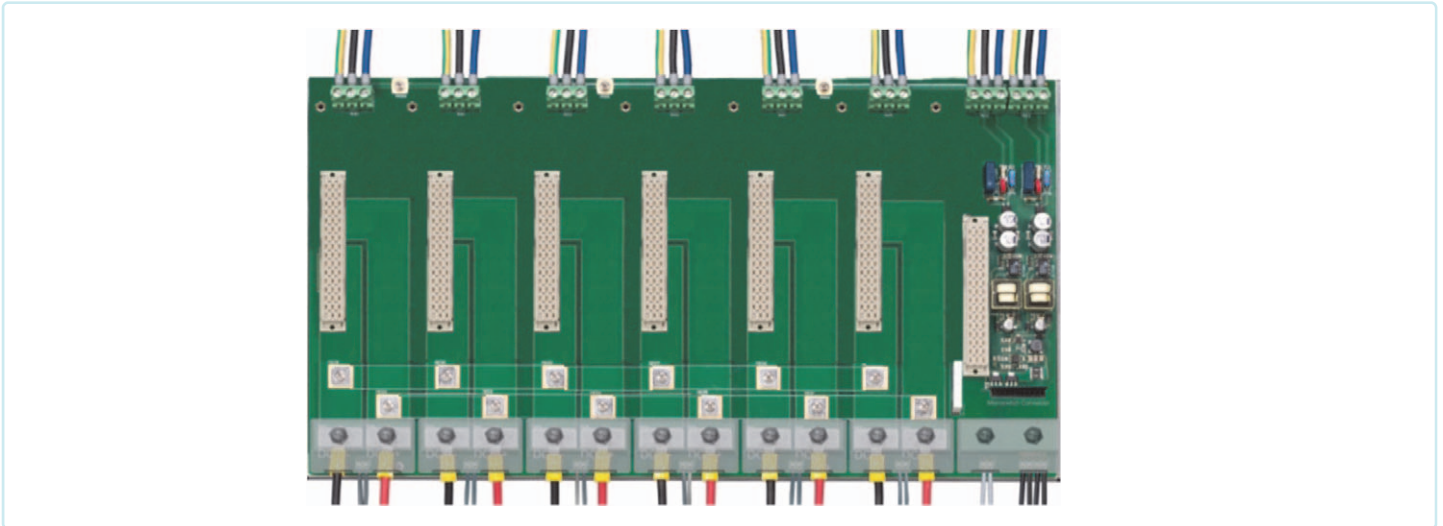

Function Diagram Dual AC Supply wiring architecture for PSS1250-HS-7-1/6-D or PSS1250-7-1/6-D fully equipped:

SAFE AREA or ZONE 2 GROUP IIC T4,
NON HAZARDOUS LOCATIONS or CLASS I, DIVISION 2, GROUPS A, B, C, D T-Code T4

PSS1250-HS-7-1-D or PSS1250-HS-7-6-D or PSS1250-7-1-D or PSS1250-7-6-D, dual AC supply, 1 redundant 150 A Output, PSO1250 overview module
six power modules connected in parallel to provide full redundancy on AC lines (AC1 and AC2) and one 150 A redundant output.

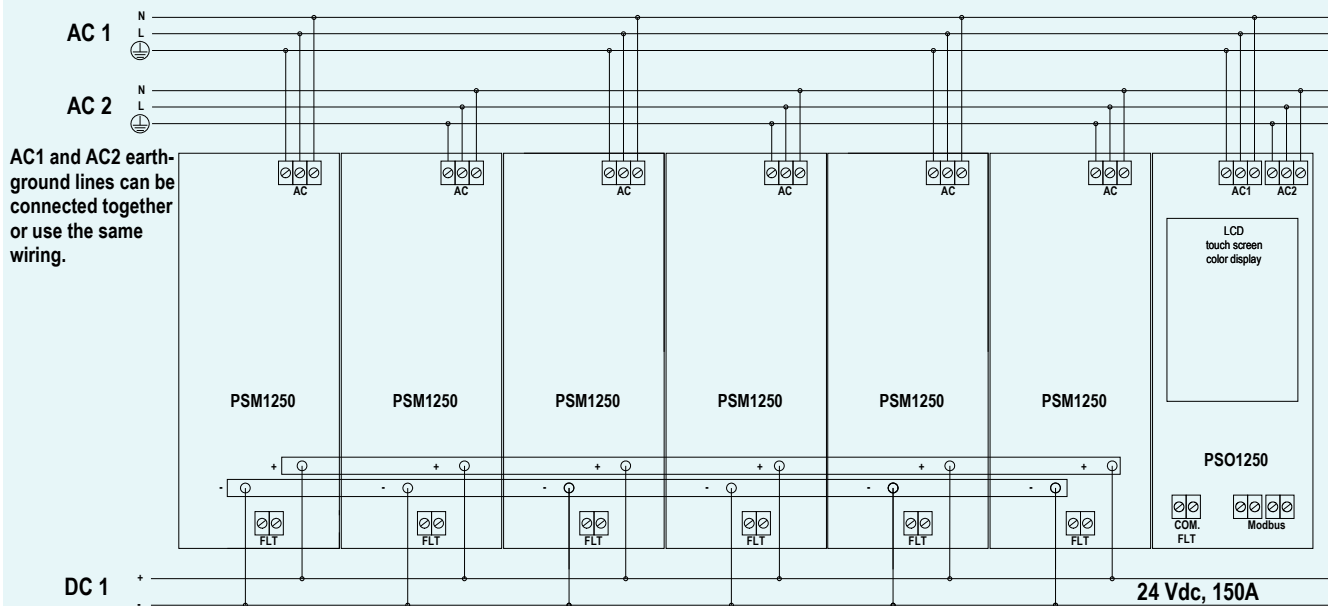

Back Panel PCB of PSS1250-HS-7-1-D or PSS1250-HS-7-6-D with Hot Swapping circuits:

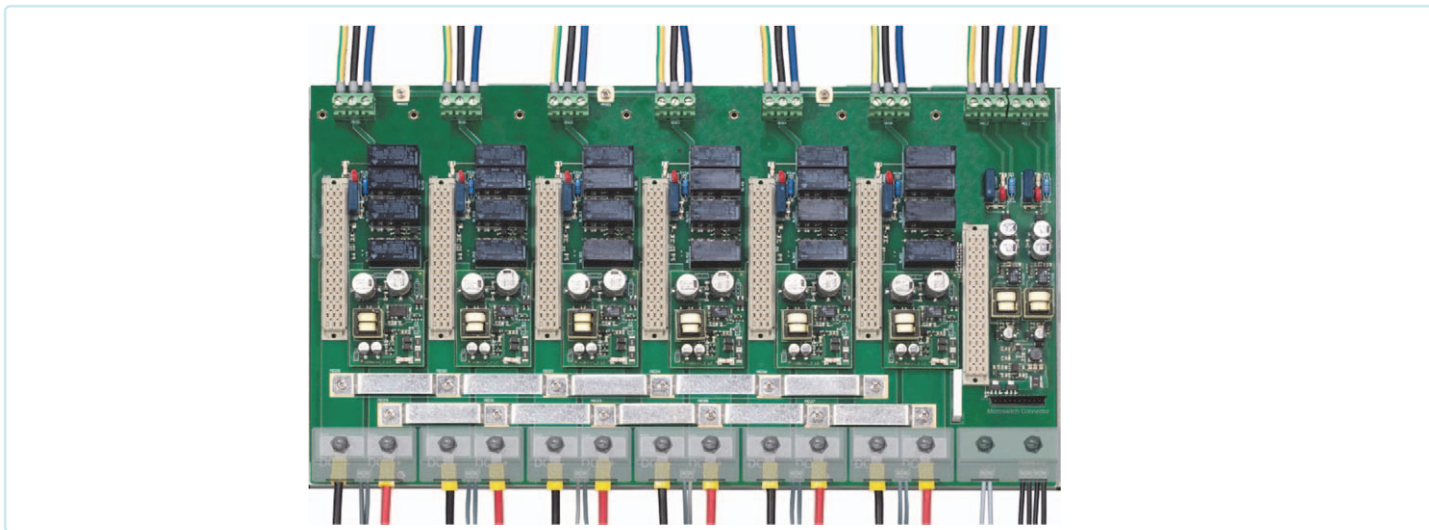

Back Panel PCB of PSS1250-7-1-D or PSS1250-7-6-D without Hot Swapping circuits:

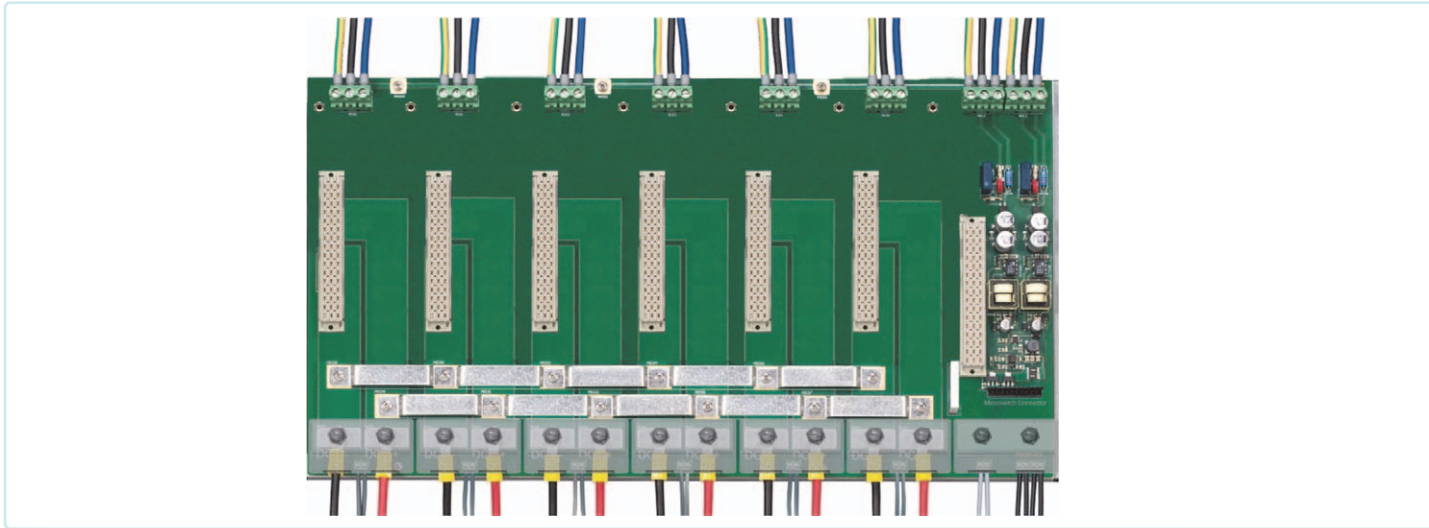

Function Diagram Dual AC Supply wiring architecture for PSS1250-HS-7-2/7-D or PSS1250-7-2/7-D fully equipped:

SAFE AREA or ZONE 2 GROUP IIC T4,
NON HAZARDOUS LOCATIONS or CLASS I, DIVISION 2, GROUPS A, B, C, D T-Code T4

PSS1250-HS-7-2-D or PSS1250-HS-7-7-D or PSS1250-7-2-D or PSS1250-7-7-D, dual AC supply, 1 redundant 100 A Out + 1 redundant 50A Out, PSO1250 overview module
four power modules connected in parallel to provide full redundancy on AC lines (AC1 and AC2) and one 100 A redundant output.
two power modules connected in parallel to provide full redundancy on AC lines (AC1 and AC2) and one 50 A redundant output.

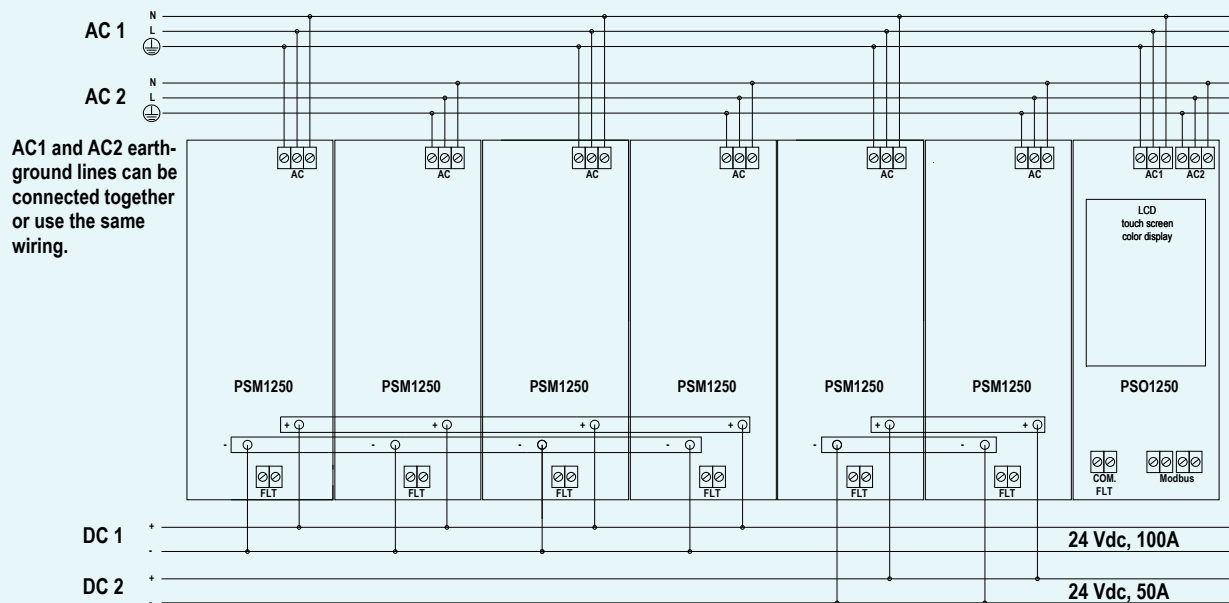

If electrical isolation between paralleled output groups is not required, DC 1 (-) and DC 2 (-) negative lines can be connected together or use the same wiring.

Back Panel PCB of PSS1250-HS-7-2-D or PSS1250-HS-7-7-D with Hot Swapping circuits:

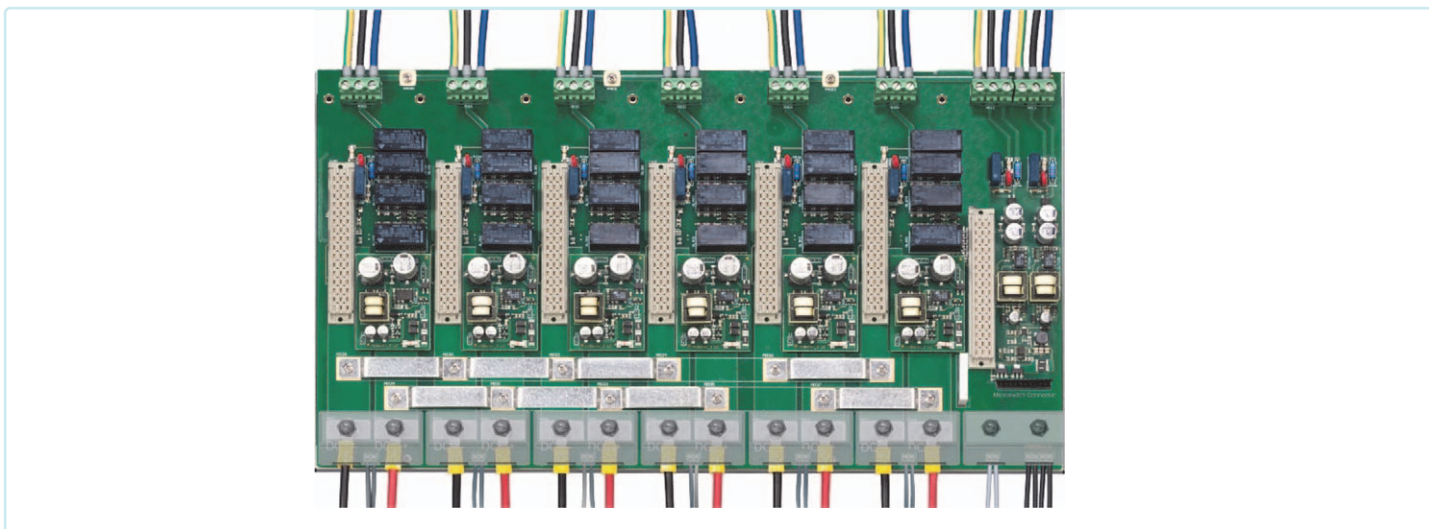

Back Panel PCB of PSS1250-7-2-D or PSS1250-7-7-D without Hot Swapping circuits:

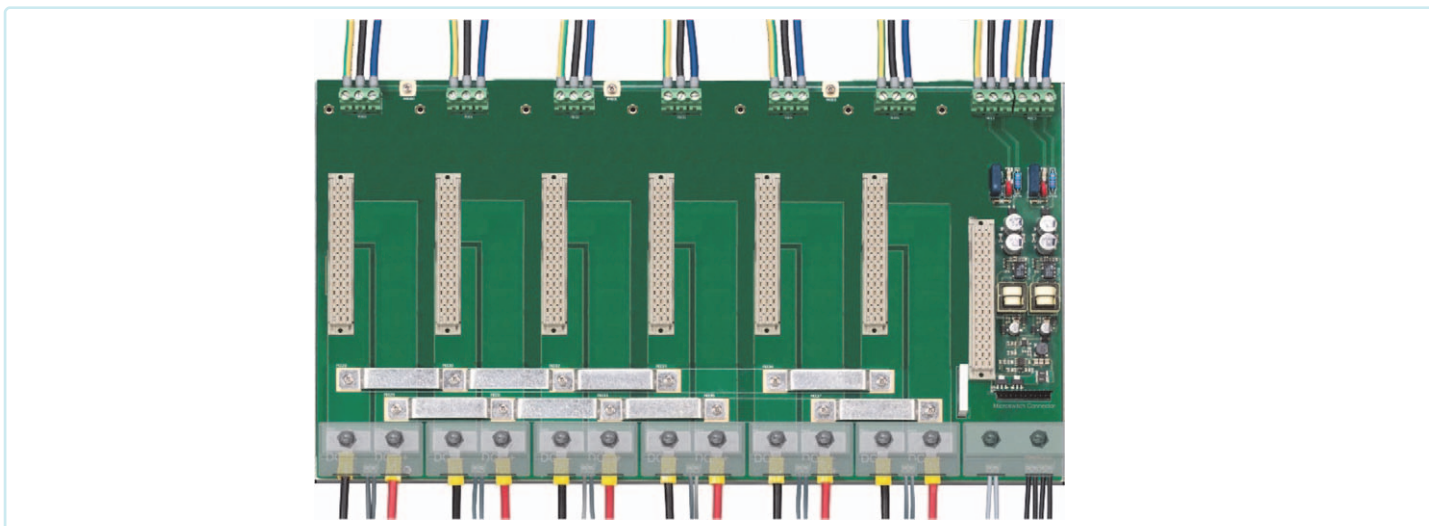

Function Diagram Dual AC Supply wiring architecture for PSS1250-HS-7-3/8-D or PSS1250-7-3/8-D fully equipped:

SAFE AREA or ZONE 2 GROUP IIC T4,
NON HAZARDOUS LOCATIONS or CLASS I, DIVISION 2, GROUPS A, B, C, D T-Code T4

PSS1250-HS-7-3-D or PSS1250-HS-7-8-D or PSS1250-7-3-D or PSS1250-7-8-D, dual AC supply, 3 redundant 50 A Outputs, PSO1250 overview module
six power modules connected in parallel in groups of two to provide full redundancy on AC lines (AC1 and AC2) and three independent 24 Vdc, 50 A redundant outputs.

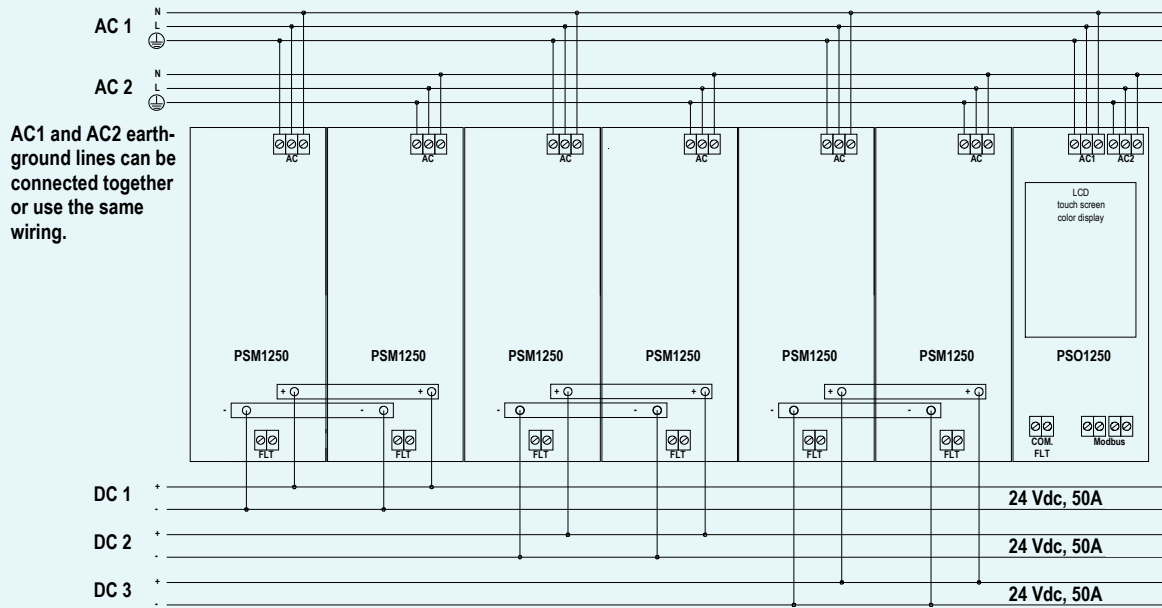

If electrical isolation between paralleled output groups is not required, DC 1 (-), DC 2 (-) and DC 3 (-) negative lines can be connected together or use the same wiring.

Back Panel PCB of PSS1250-HS-7-3-D or PSS1250-HS-7-8-D with Hot Swapping circuits:

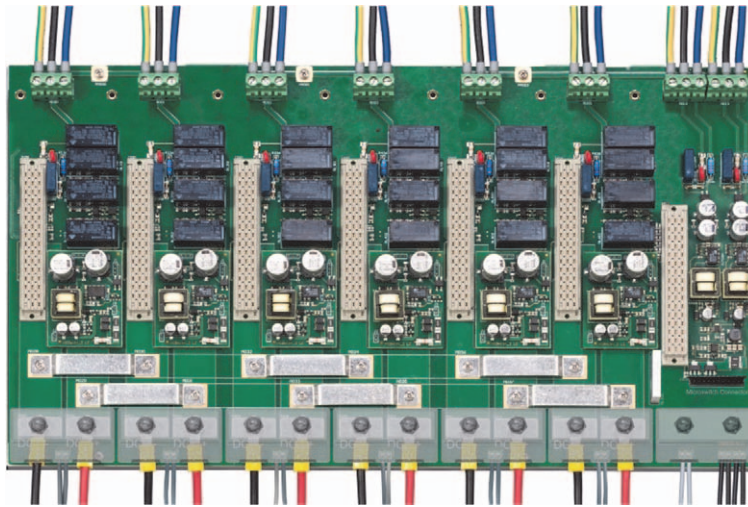

Back Panel PCB of PSS1250-7-3-D or PSS1250-7-8-D without Hot Swapping circuits:

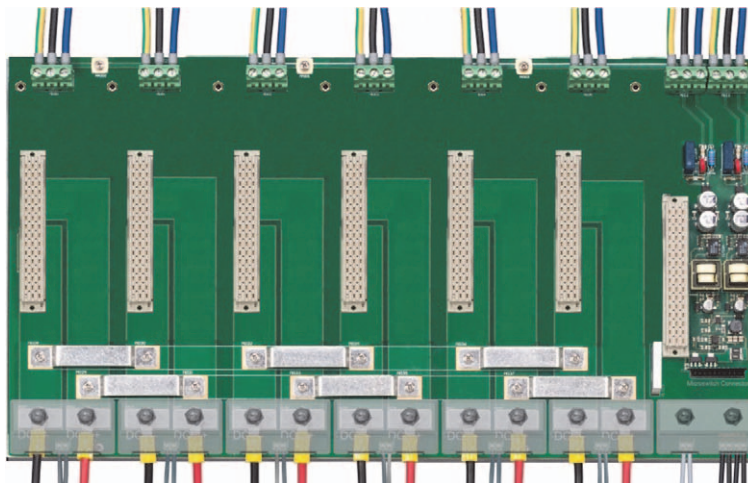

Function Diagram Dual AC Supply wiring architecture for PSS1250-HS-7-4/9-D or PSS1250-7-4/9-D fully equipped:

SAFE AREA or ZONE 2 GROUP IIC T4,
NON HAZARDOUS LOCATIONS or CLASS I, DIVISION 2, GROUPS A, B, C, D T-Code T4

PSS1250-HS-7-4-D or PSS1250-HS-7-9-D or PSS1250-7-4-D or PSS1250-7-9-D, dual AC supply, 2 redundant 100 A Outputs, PSO1250 overview module
Two groups of three power modules connected in parallel. Each group provides 100 A redundant Output with redundancy 2+1 (100 A + 50 A).

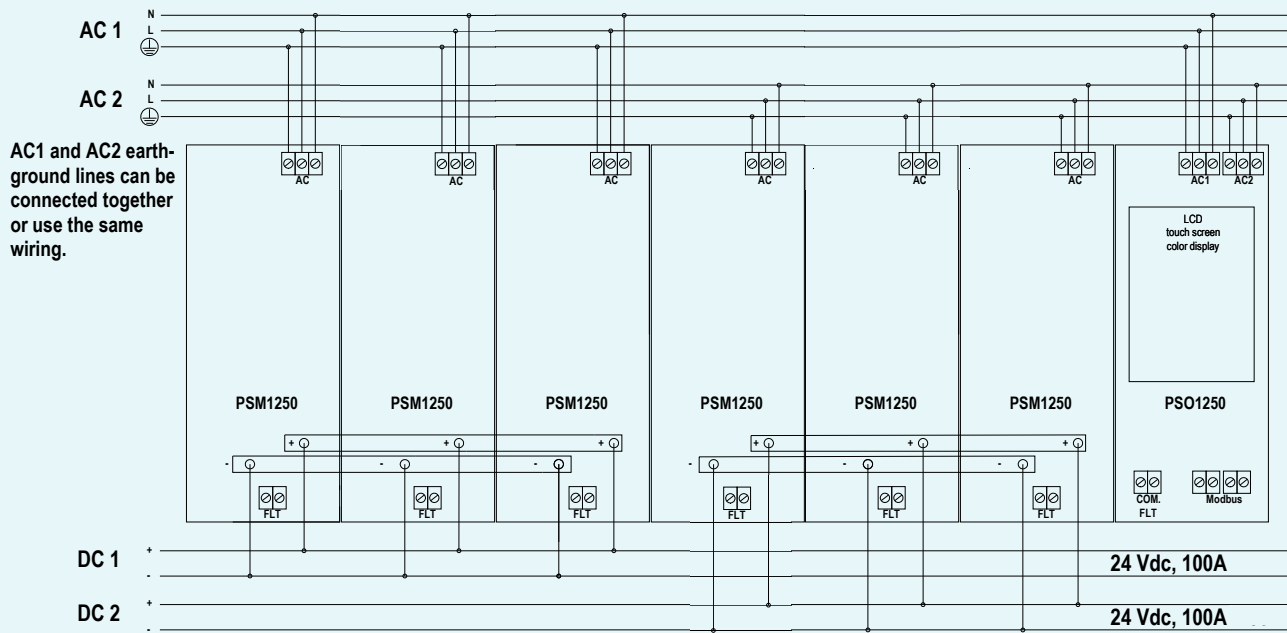

If electrical isolation between paralleled output groups is not required, DC 1 (-) and DC 2 (-) negative lines can be connected together or use the same wiring.

Back Panel PCB of PSS1250-HS-7-4-D or PSS1250-HS-7-9-D with Hot Swapping circuits:

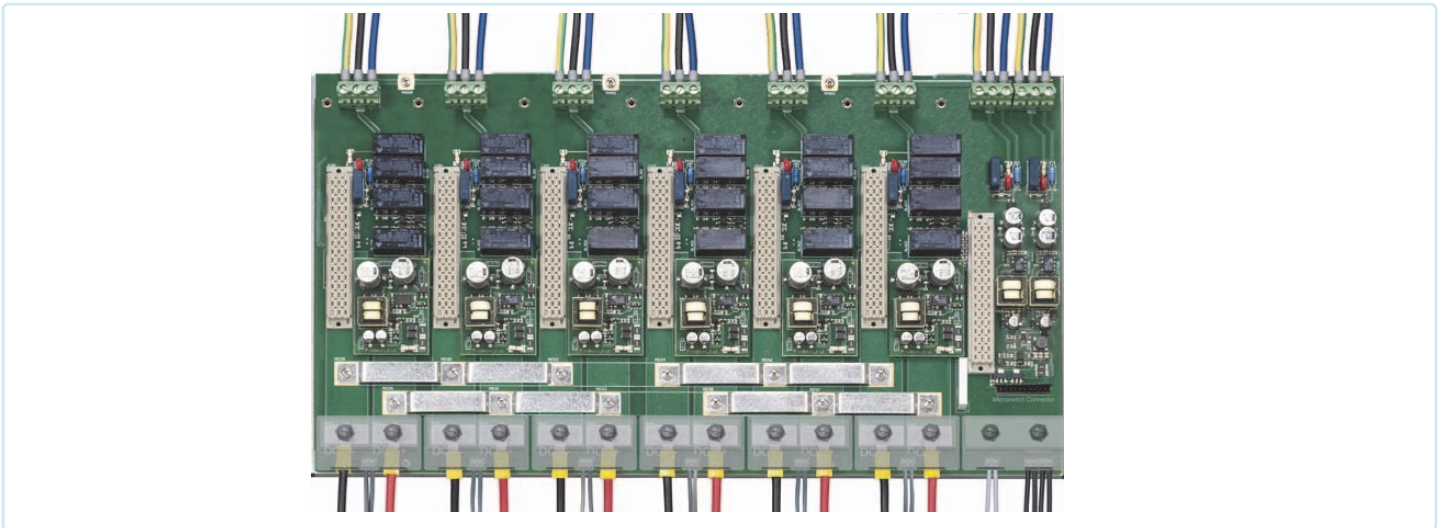

Back Panel PCB of PSS1250-7-4-D or PSS1250-7-9-D without Hot Swapping circuits:

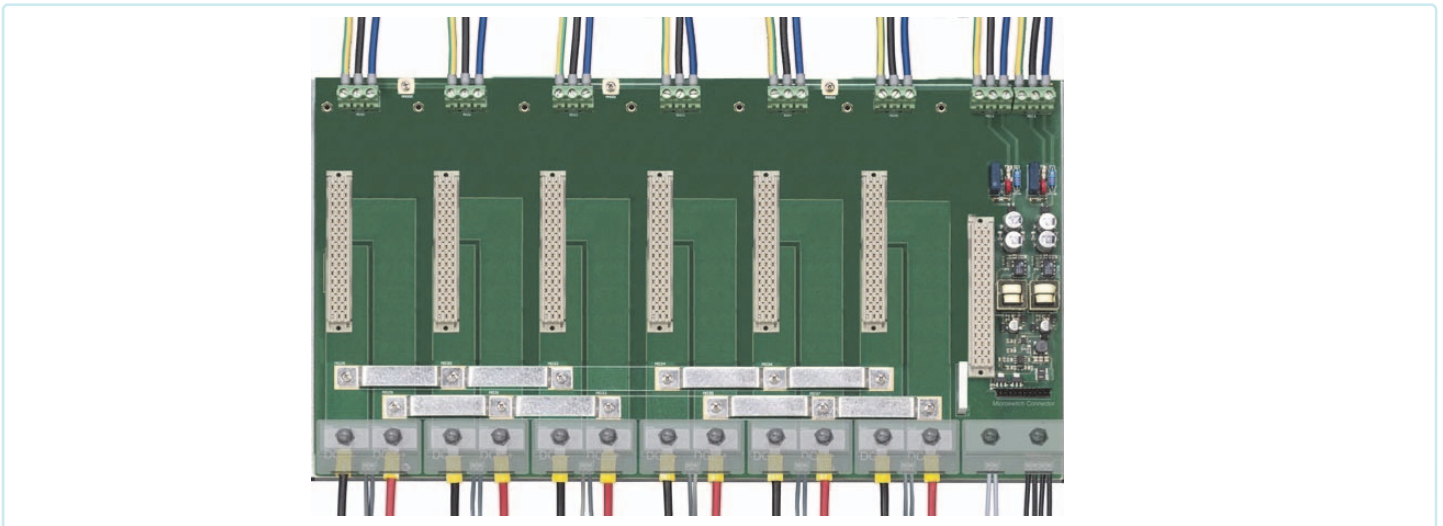

Function Diagram Dual AC Supply wiring architecture for PSS1250-HS-3-D or PSS1250-3-D fully equipped:

SAFE AREA or ZONE 2 GROUP IIC T4,
NON HAZARDOUS LOCATIONS or CLASS I, DIVISION 2, GROUPS A, B, C, D T-Code T4

PSS1250-HS-3-D or PSS1250-3-D, dual AC supply, 1 redundant 50 A Output, PSO1250 overview module
two power modules connected in parallel to provide full redundancy on AC lines (AC1 and AC2) and one 50 A redundant output.

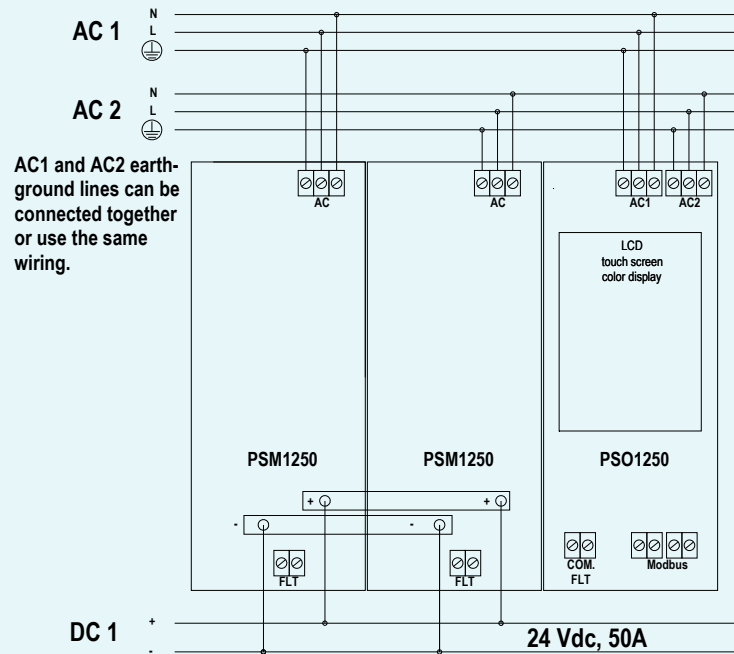

Back Panel PCB of PSS1250-HS-3-D with Hot Swapping circuits:

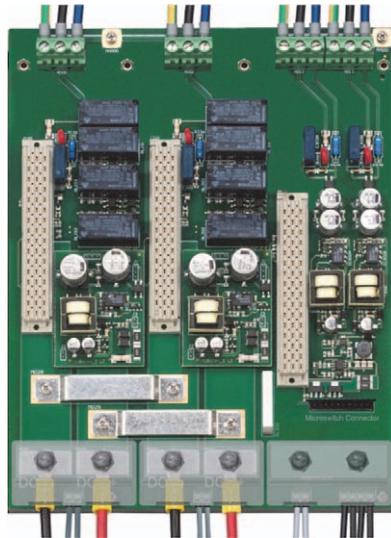

Back Panel PCB of PSS1250-3-D without Hot Swapping circuits:

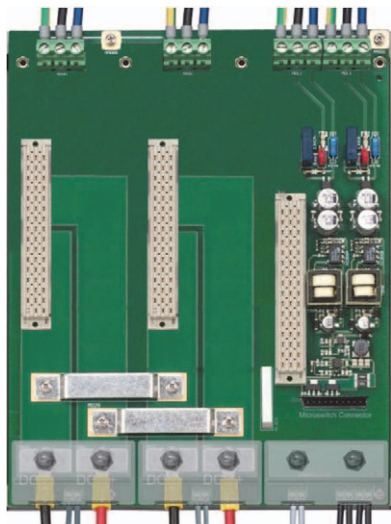

Function Diagram Dual AC Supply wiring architecture for PSS1250-HS-2 or PSS1250-2 fully equipped:

SAFE AREA or ZONE 2 GROUP IIC T4,
NON HAZARDOUS LOCATIONS or CLASS I, DIVISION 2, GROUPS A, B, C, D T-Code T4

PSS1250-HS-2 or PSS1250-2, dual AC supply, 1 redundant 50 A Output.

two power modules connected in parallel to provide full redundancy on AC lines (AC1 and AC2) and one 50 A redundant output.

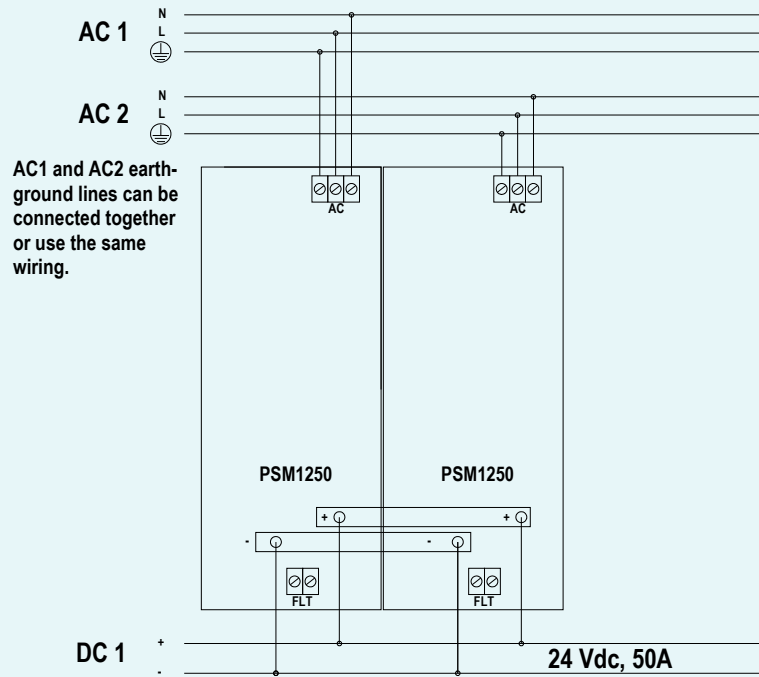

Back Panel PCB of PSS1250-HS-2 with Hot Swapping circuits:

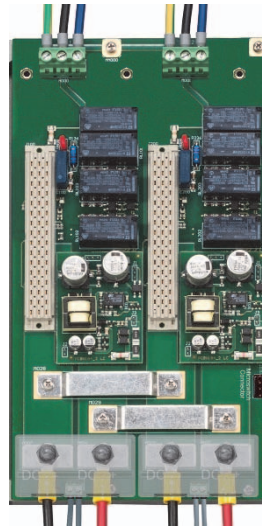

Back Panel PCB of PSS1250-2 without Hot Swapping circuits:

